

BECKER
▶ **ICEline**



**INSTRUMENT TABLES
AND SERVING TROLLEYS**
WATER-RESISTANT, STRONG & ROBUST

BECKER ICEline

TO MEET YOUR EXACT NEEDS!

How many miles of corridors does your hospital staff cover each day? Whatever the mileage, our ICEline range guarantees that they keep a cool head at all times.

And helps to keep everything together. Whether in use as an instrument table or as a serving trolley, this functional product line always cuts a good figure.

Strong, agile and flexible, ICEline is a reliable companion for all your needs. In the creation of this line, we placed our focus, as always, on quality and hygiene, but also paid special attention to sustainability and innovation.

The products of our new ICEline combine all these qualities.

Most of the trolleys can even be machine washed.

Find out for yourself and discover a new versatile world of instrument tables and serving trolleys.

ICE. ICE. Baby.



CONTENTS

▶ **04.**
Becker
quality

▶ **06.**
Unbeatable
benefits

▶ **08.**
Instrument
tables

▶ **12.**
Instrument table
equipment

▶ **14.**
Practical
accessories

▶ **18.**
Serving trolleys



BECKERQUALITY

We are proud to introduce our new BECKER ICEline, combining strength, agility and flexibility.

Simply great.

INSTRUMENT TABLE

TABLE TOPS

Three stylish models – all in chromium-nickel steel with a fine-brushed finish.

The special advantage: each table top fits perfectly – no rattling in the corridors

STANDARD SIZES

650 x 450 mm
750 x 650 mm
950 x 650 mm
1250 x 650 mm

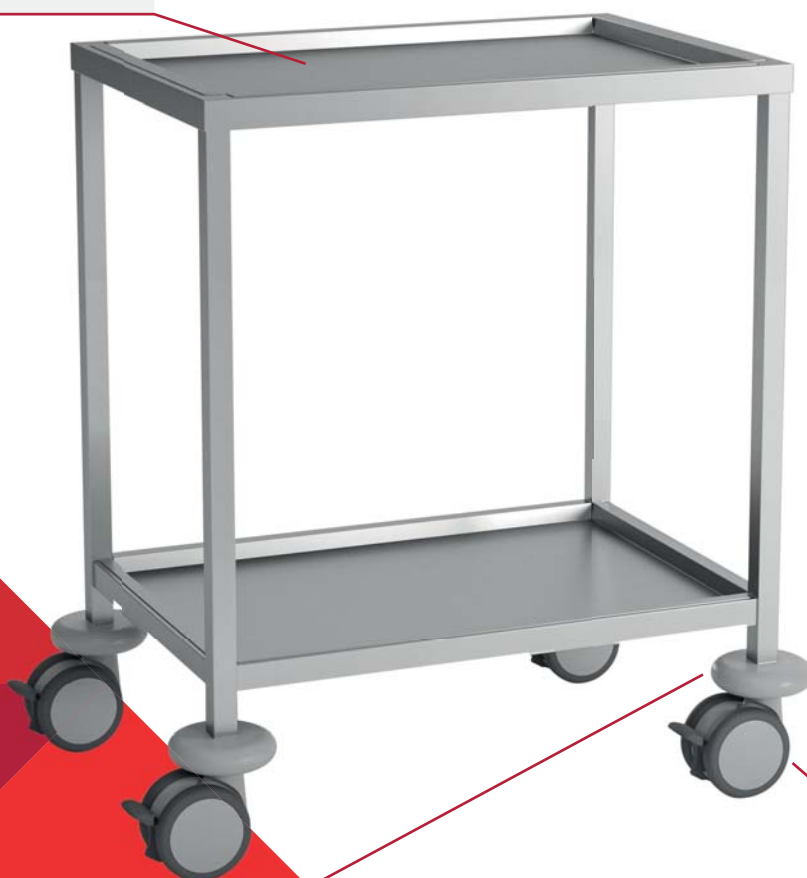

EFFICIENT WALL PROTECTORS

for maximum protection of corners, edges and walls.

DOUBLE CASTORS

Ø 100 mm, electrically conductive, with brake.
MRI-safe versions upon special request.

SERVING TROLLEYS

CHASSIS

made of chromium-nickel steel
Material AISI 304 (1.4301). Suitable for
machine washing.

STANDARD SIZES

400 x 550 mm
750 x 550 mm
1050 x 550 mm

SHELVES

Shelf permanently welded into place,
with raised edge.

PUSH-HANDLE

two tubular push-handles \varnothing 25 mm.



WALL PROTECTORS

ensuring maximum protection.

SWIVEL CASTORS

To allow easy movement
4 versatile swivel castors, \varnothing 125 mm
electrically conductive, with brake,
compact design. Closed sides to
meet strict hygiene requirements.

UNBEATABLE BENEFITS

FROM CHOOSING BECKER ICELINE!

STRONG, AGILE & VARIABLE

Ideal requirements for effective work support.

WASHABLE

All trolleys with this marking are suitable for machine washing.



NEW DESIGN

bringing ease, functionality and a modern flair to your hospital.

STEEL

Using the material we trust most, our priority is on a long service life. A clear signal for the future.

QUALITY AND SMART CONSTRUCTION

Here we have stuck to our principles: a robust construction to ensure perfect hygiene and quiet and easy operation.



CNS: AN ALLROUND-TALENT

WE ARE COMMITTED TO SUSTAINABILITY!

CHROMIUM-NICKEL STEEL

- ▶ attractive appearance and ideal processing qualities ensuring a long service life
- ▶ timeless design and reusability



Sustainability is of great importance for us!

In using steel, we rely on durable, robust and economical products without the need for constant remanufacturing. In addition, steel can be recycled almost indefinitely thanks to its unique recycling properties.

WHAT EXACTLY IS CNS AISI 304 (1.4301)?

This is the most frequently used member of the austenitic chromium-nickel steel alloy family and has the following properties:

- ▶ high resistance to chemicals and stresses
- ▶ corrosion resistance thanks to chromium
- ▶ withstands temperatures up to 600 °C

Fantastic!



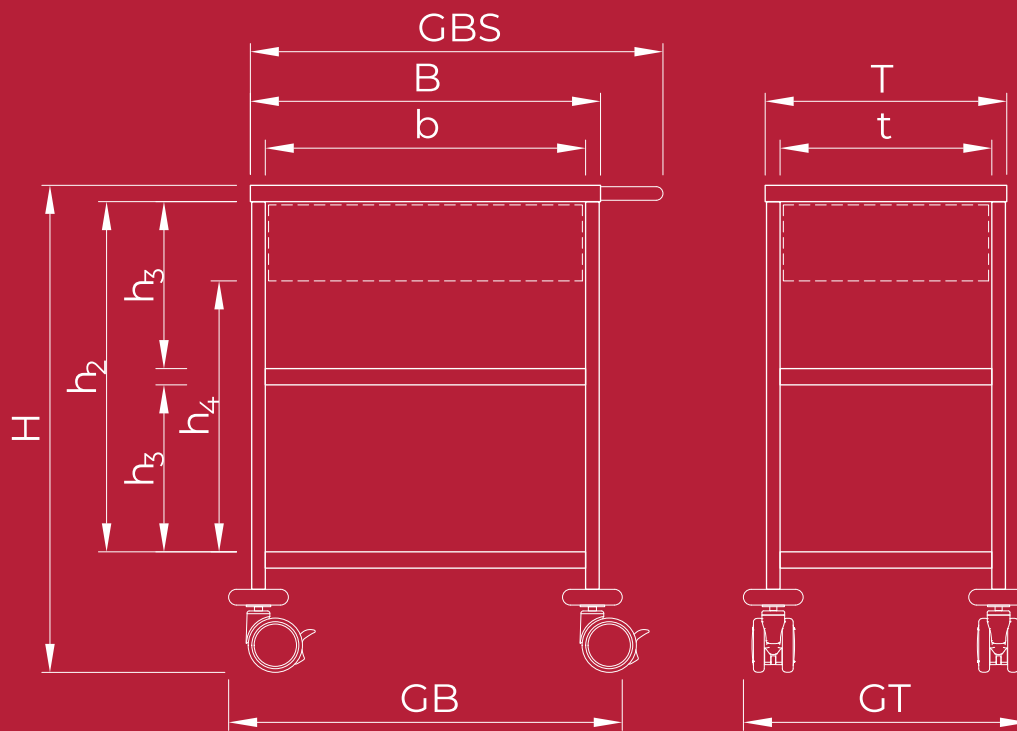

H w. castors 75, 100	650	800	900	1000
H w. castors 65	610	760	860	960
H w. castors 125	685	835	935	1035
h₂	390	540	640	740
h₃	180	255	305	355
h₄ (w. drawer)	245	395	495	595

B, T	450	650	750	950	1250
b, t	390	590	690	890	1190
GB, GT	530	730	830	1030	1330
GBS		805	905	1105	1405

INSTRUMENT TABLES

CLASSICAL, RE-DEFINED

ICEline instrument tables – trusted companions which last for years. With enormous flexibility in the bends thanks to their sturdy construction and high-quality material.

Find out for yourself.

INSTRUMENT TABLES with double castors, Ø 100 mm

▶ top shelf: flat, welded on
 ▶ bottom shelf: flat, welded on

▶ Height	Size			
	650 x 450	750 x 650	950 x 650	1250 x 650
650 mm	TI112 10104	TI312 10104	TI512 10104	TI712 10104
800 mm	TI132 10104	TI332 10104	TI532 10104	TI732 10104
900 mm	TI152 10104	TI352 10104	TI552 10104	TI752 10104
1000 mm	TI172 10104	TI372 10104	TI572 10104	TI772 10104

Article number

INSTRUMENT TABLES with double castors, Ø 100 mm

▶ top shelf: with raised edge, on a tubular frame
 ▶ bottom shelf: flat, welded on

▶ Height	Size			
	650 x 450	750 x 650	950 x 650	1250 x 650
650 mm	TI112 R0104	TI312 R0104	TI512 R0104	TI712 R0104
800 mm	TI132 R0104	TI332 R0104	TI532 R0104	TI732 R0104
900 mm	TI152 R0104	TI352 R0104	TI552 R0104	TI752 R0104
1000 mm	TI172 R0104	TI372 R0104	TI572 R0104	TI772 R0104

Article number

INSTRUMENT TABLES with double castors, Ø 100 mm

▶ top shelf: with raised edge and guard on three sides, on a tubular frame
 ▶ bottom shelf: flat, welded on

▶ Height	Size			
	650 x 450	750 x 650	950 x 650	1250 x 650
650 mm	TI112 G0104	TI312 G0104	TI512 G0104	TI712 G0104
800 mm	TI132 G0104	TI332 G0104	TI532 G0104	TI732 G0104
900 mm	TI152 G0104	TI352 G0104	TI552 G0104	TI752 G0104
1000 mm	TI172 G0104	TI372 G0104	TI572 G0104	TI772 G0104

Article number

Load-bearing capacity for table sizes 650x450, 750x650, 950x650

- ▶ 60 kg per shelf (for 2 levels + Ø 100 mm castors)
- ▶ 90 kg per shelf (for 2 levels + Ø 125 mm castors)

Load-bearing capacity for table size 1250x650

- ▶ 50 kg per shelf (for 2 levels + Ø 100 mm castors)
- ▶ 50 kg per shelf (for 2 levels + Ø 125 mm castors)

INSTRUMENT TABLES with double castors, Ø 100 mm

top shelf: with raised edge, on a tubular frame
 bottom shelf: with raised edge, on a tubular frame

▶ Height	Size			
	650 x 450	750 x 650	950 x 650	1250 x 650
650 mm	TI112 R0R04	TI312 R0R04	TI512 R0R04	TI712 R0R04
800 mm	TI132 R0R04	TI332 R0R04	TI532 R0R04	TI732 R0R04
900 mm	TI152 R0R04	TI352 R0R04	TI552 R0R04	TI752 R0R04
1000 mm	TI172 R0R04	TI372 R0R04	TI572 R0R04	TI772 R0R04

Article number

INSTRUMENT TABLES with double castors, Ø 100 mm and drawer

top shelf: flat, on a tubular frame
 bottom shelf: flat, welded on

▶ Height	Size			
	650 x 450	750 x 650	950 x 650	1250 x 650
650 mm	TI112 F0154	TI312 F0154	TI512 F0154	TI712 F0154
800 mm	TI132 F0154	TI332 F0154	TI532 F0154	TI732 F0154
900 mm	TI152 F0154	TI352 F0154	TI552 F0154	TI752 F0154
1000 mm	TI172 F0154	TI372 F0154	TI572 F0154	TI772 F0154

Article number

INSTRUMENT TABLES with Ø 125 mm swivel castors and push handle

top shelf: with raised edge, on a tubular frame
 bottom shelf: with raised edge, welded on

▶ Height	Size			
	650 x 450	750 x 650	950 x 650	1250 x 650
650 mm	TI112 R0327	TI312 R0327	TI512 R0327	TI712 R0327
800 mm	TI132 R0327	TI332 R0327	TI532 R0327	TI732 R0327
900 mm	TI152 R0327	TI352 R0327	TI552 R0327	TI752 R0327
1000 mm	TI172 R0327	TI372 R0327	TI572 R0327	TI772 R0327

Article number

The instrument tables are of a modular construction allowing individual combinations of tops, shelves and elements such as drawers and push handles. Just let us know your needs.

SHELF DETAILS

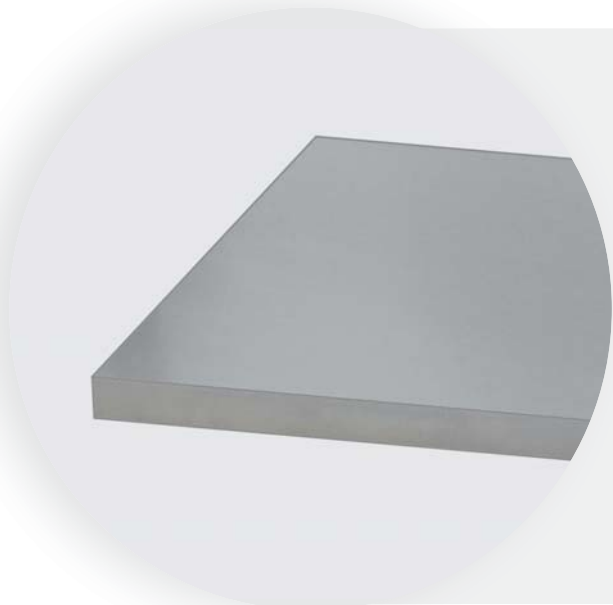

FLAT SHELF

Chromium-nickel steel

welded on



on a tubular frame

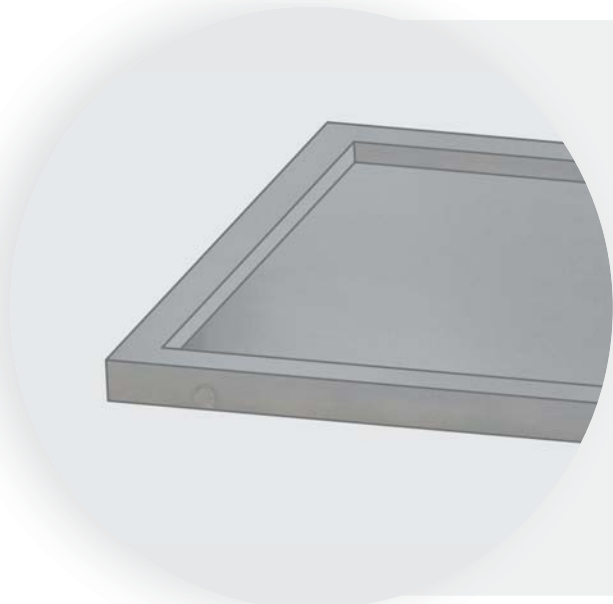

SHELF WITH RAISED EDGE

Chromium-nickel steel

welded on



on a tubular frame

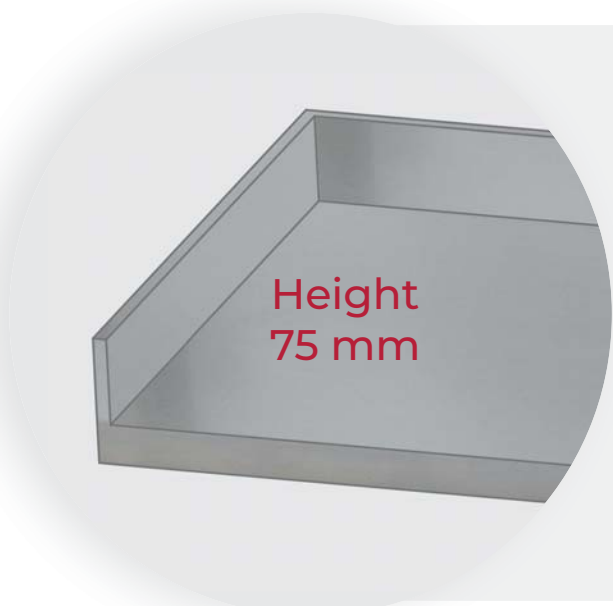

SHELF WITH RAISED EDGE AND GUARD ON THREE SIDES

Chromium-nickel steel

on a tubular frame





INSTRUMENT TABLE EQUIPMENT

PERFECTLY TAILORED TO YOUR NEEDS

We want to give you the best possible assistance in caring for your patients. Customise your instrument table to suit your individual needs. Our modular equipment options provide you with many possible ways of configuring your individual ICEline instrument table.

Quality to be proud of.

STANDARD RAIL ATTACHMENT

AVAILABLE OPTIONS

STANDARD RAIL ATTACHMENT 25 X 10 MM

chromium-nickel steel
permanently attached
choice of 5 different overall heights,
standard rails can be positioned as desired



EXTENSION

AVAILABLE OPTIONS

CHROMIUM-NICKEL STEEL EXTENSION

flat, can be folded down
and enlarges the work top,
hygienic design



MAGNES SIDE PANELS

AVAILABLE OPTIONS

MAGNETIC STAINLESS STEEL PANEL

can be removed without tools,
3 options:

- ▶ panel for MAGNES accessories
- ▶ panel with push-handle
- ▶ panel with standard rail

















ACCESSORIES

THE FINAL TOUCH

Customise your ICEline table to suit the needs of your work environment with total flexibility. Our accessories catalogue offers a wide range of practical elements designed to make your work easier.

Wide selection for day-to-day use.

SYRINGE AND CANNULA DISPENSERS

<p>► Description, dimensions (WxDxH)</p>			
<p>3 Tilting bins, 600 x 215 x 245 mm</p> 	<p>W1060 70010</p>	<p>W1460 70010A</p>	
<p>4 Tilting bins, 600 x 180 x 210 mm</p> 	<p>W1060 70100</p>	<p>W1460 70100A</p>	
<p>5 Tilting bins, 600 x 145 x 165 mm</p> 	<p>W1060 71000</p>	<p>W1460 71000A</p>	
<p>5 + 3 Tilting bins, 600 x 200 x 420 mm</p> 		<p>W1460 71010A</p>	
<p>2 x 4 Tilting bins, 600 x 170 x 420 mm</p> 		<p>W1460 70200A</p>	
<p>5 + 4 Tilting bins, 600 x 170 x 390 mm</p> 		<p>W1460 71100A</p>	
<p>2 x 5 Small tilting bins, 600 x 170 x 340 mm</p> 		<p>W1460 72000A</p>	
<p>► First in - First out</p>			
<p>3 Bins Fi/Fo, 600 x 220 x 245 mm</p> 	<p>W1060 70011</p>	<p>W1460 70011A</p>	
<p>5 Bins Fi/Fo, 600 x 165 x 165 mm</p> 	<p>W1060 71001</p>	<p>W1460 71001A</p>	
<p>5 + 3 Bins Fi/Fo, 600 x 210 x 420 mm</p> 		<p>W1460 71011A</p>	



magnetic mounting on MAGNES side panels



products can be hung on the standard rail attachment







products can be hung on a panel with standard rail

GLOVE DISPENSER

▶ Description, dimensions (WxDxH)				
Glove dispenser Hori 1 for 1 box of non-sterile gloves, max. box size: 285 x 90 x 135 mm	 RAL	W1030 20010	W1430 20010U	W1430 20010U
Glove dispenser Vert 1 for 1 box of non-sterile gloves, max. box size: 285 x 90 x 135 mm	 RAL	W1030 20010	W1430 20015A	W1430 20015W

DISPOSAL BOXES

▶ Description				
Holder including disposal box set, 10 boxes 1.5 l each, (PP, Ø 140 x 145 mm)	 CNS	W1050 40001	W1450 40001U	W1450 40001U
Holder for disposal box, up to 12 liters, tailored to fit customer's box (The detailed specification of the box is required in case of order)	 Example CNS	W1050 40016	W1450 40016U	W1450 40016U

DESINFECTATION

▶ Description				
Dispenser for one 500 ml euro bottle detergent/disinfectant (without bottle), manual		W1032 90050	W1432 90050A	W1432 90050W
Dispenser for one 500 ml euro bottle detergent/disinfectant (without bottle) with drip tray (CNS), manual		W1032 90052	W1432 90052A	W1432 90052W
FlowPack holder max. pack size 250 x 120 x 120 mm (without pack)	 CNS	W1038 40020	W1438 40020A	W1438 40020W

WASTE COLLECTION

► Description, dimensions (WxDxH)



Waste container system with 19 l bucket, (PP, 400x190x415 mm), incl. 1 roll of 35-litre waste bag



W1055
20191

W1455
20191W

HOLDERS FOR WASTE CONTAINER

► Description



Holder for PP-container attachment on the long side



W1025
40014

W1425
40014U

W1425
40014U

Holder for PP-container attachment on the short side



W1025
40015

W1425
40015W

Holder for one tray (GN 1/3)



W1025
40210

W1425
40210U

W1425
40210U

WASTE CONTAINER

► Description, dimensions (WxDxH)

to be hooked into holders

Polypropylene (PP) container, 300 x 225 x 130 mm, with slotted lid, can be sterilised at temperatures up to 134 °C



W9150 70001

Polypropylene (PP) container, 300 x 225 x 130 mm, with closed lid, can be sterilised at temperatures up to 134 °C



W9150 70002

GN-box / drip pan GN 1/3 – 100, 325 x 176 x 100 mm, volume approx 4 l, chromium-nickel steel



W9120 40210

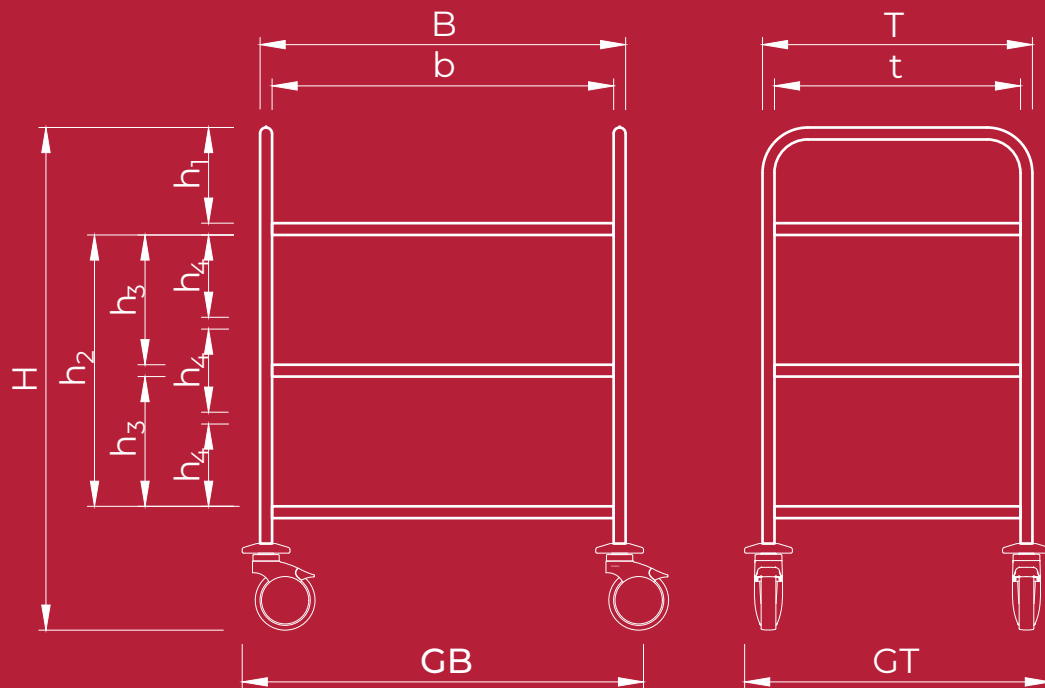

H w. castors 125	1050	1250
h₁	200	100
h₂	565	
h₃	270	
h₄		270

B, T	400	550	750	1050
b, t	360	510	710	1010
GB, GT	490	640	840	1140

SERVING TROLLEYS

PRACTICAL AND WASHABLE

Serving trolleys are always a useful aid in your everyday work – no matter what it is that you need to transport.

With their practical push-handles and manoeuvrable castors, ICEline serving trolleys are strong helpers. With up to 90 kg load capacity per shelf, a total load capacity of 180 kg and suitable for use with washing equipment (CWMs, TWMs) ICEline serving trolleys have no need to hide their merits.

Quality you can see.

SERVING TROLLEYS



For 2 GN 1/1
Nom. dimensions **400 x 550**
Article No.: TG132 30307



For 3 GN 1/1
Nom. dimensions **400 x 550**
Article No.: TG133 33307



For 4 GN 1/1
Nom. dimensions **400 x 550**
Article No.: TG154 33307



For 4 GN 1/1-
Nom. dimensions **750 x 550**
Article No.: TG332 30307



For 6 GN 1/1
Nom. dimensions **750 x 550**
Article No.: TG333 33307



For 8 GN 1/1
Nom. dimensions **750 x 550**
Article No.: TG354 33307



For 6 GN 1/1
Nom. dimensions **1050 x 550**
Article No.: TG532 30307



For 9 GN 1/1
Nom. dimensions **1050 x 550**
Article No.: TG533 33307



For 12 GN 1/1
Nom. dimensions **1050 x 550**
Article No.: TG554 33307

BECKER

Metallwarenfabrik
Walter H. Becker GmbH
Anzenkirchener Straße 4
84371 Triftern, Germany

Phone +49 (0) 8562 9605-0
info@becker-triftern.de
www.becker-triftern.de

We will gladly advise you!

